

HOOVER

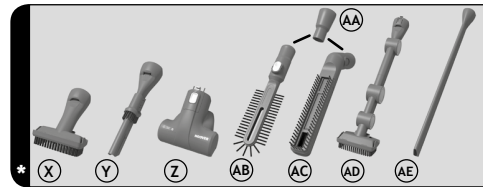

USER MANUAL (GB) P 01
 MANUEL D'UTILISATION (FR) P 08
 BEDIENINGSHANDLEIDING (DE) P 15
 MANUALE D'ISTRUZIONI (IT) P 21
 MANUAL DE INSTRUÇÕES (PT) P 27
 MANUAL DE INSTRUCCIONES (ES) P 33
 GEBRUIKSHANDLEIDING (NL) P 39
 BRUGERVEJLEDNING (DK) P 45
 BRUKSANVISNING (NO) P 51
 KÄYTTÖOHJE (FI) P 57
 INSTRUKTIONSMANUALISE P 63
 ΟΔΗΓΙΕΣ ΧΡΗΣΕΩΣ (GR) P 69
 РУКОВОДСТВО ПОЛЬЗОВАТЕЛЯ (RU) P 75
 INSTRUKCJA OBSŁUGI (PL) P 81
 NÁVOD K OBSLUŽE (CZ) P 87
 NAVODILA ZA UPORABO (SI) P 93
 KULLANIM KILAVUZU (TR) P 99

PRINTED IN P.R.C.
48030510

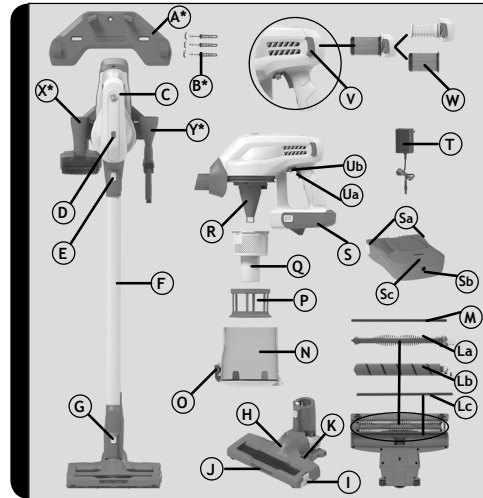

* Certain Models Only

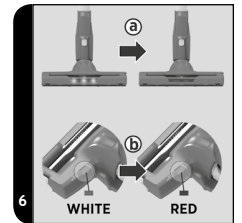
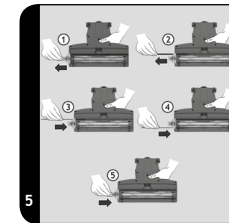
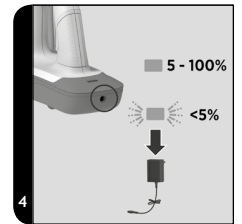
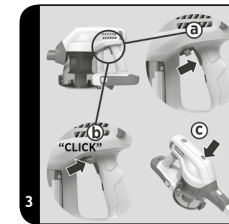
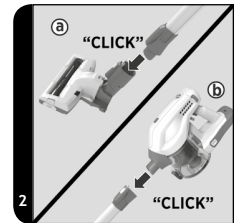
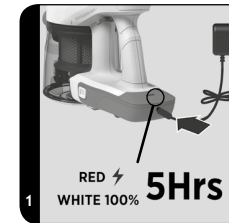

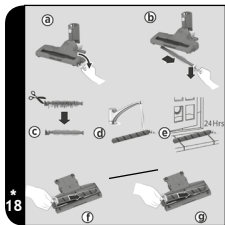
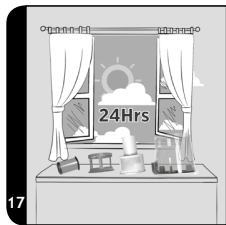
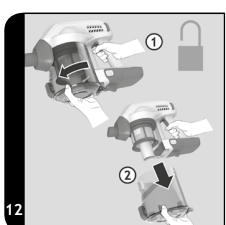
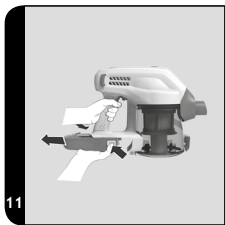
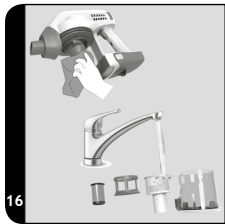
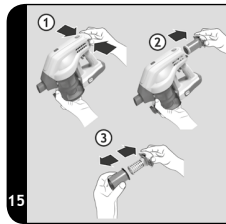
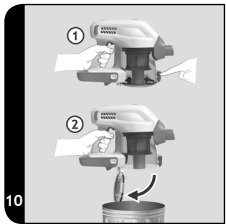
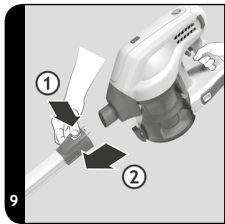
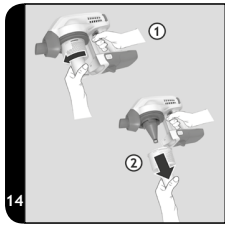
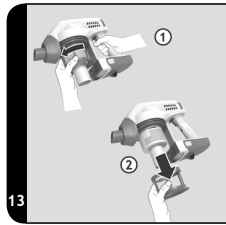
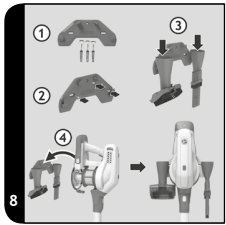
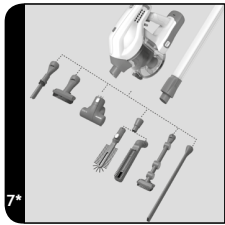

* Certain Models Only

INSTRUCTIONS FOR SAFE USE

This appliance should only be used for domestic cleaning, as described in this user guide. Please ensure that this guide is fully understood before operating the appliance.

Always switch off and remove the charger from the socket before cleaning the appliance or any maintenance task.

This appliance can be used by children aged from 8 years and above and persons with reduced physical, sensory or mental capabilities or lack of experience and knowledge if they have been given supervision or instruction concerning use of the appliance in a safe way and understand the hazards involved. Children shall not play with the appliance. Cleaning and user maintenance shall not be made by children without supervision.

If the power cord is damaged stop using the appliance immediately. To avoid a safety hazard, an authorised Hoover service engineer must replace the power cord.

Keep hands, feet, loose clothing and hair away from rotating brushes.

Use only the original charger supplied with the appliance.

Check that your supply voltage is the same as that stated on the charger.

This appliance is supplied with a double insulated battery charger which is only suitable for insertion in a 230V (UK 240V) socket outlet.

Plug the charger in to suitable socket outlet and connect the charger jack plug to the appliance.

When charging the appliance, the power switch lever must be in the off position.

Before first use, charge your appliance for at least 24 hours. The battery pack LED light will illuminate RED during charging and will turn WHITE when fully charged.

Re-connect the appliance to the charger after use to recharge the battery.

Never charge the batteries in temperatures above 37°C or below 0°C.

It is normal for the charger to become warm to the touch when charging.

Do not unplug the charger by pulling on the power cord.

Unplug the charger in the event of prolonged absence (holidays, etc.). Recharge appliance again before use as batteries may self discharge over increased periods of storage.

If the appliance is to be disposed of the batteries must first be removed. The appliance must be disconnected from the supply mains when removing the battery. Dispose of the batteries safely. Run the appliance until it stops because the batteries are fully discharged. Used batteries should be taken to a recycling station and not disposed of with household waste. To remove the batteries, please contact the Hoover Customer Centre or proceed according to the following instructions.

IMPORTANT: Always fully discharge the batteries before removal.

Run the cleaner until the batteries are completely empty.

Remove the charger jack plug from the appliance.

Press the battery pack release buttons and slide to remove. **[11]**

Note: Should you experience any difficulty in dismantling the unit or for more detailed information on treatment, recovery and recycling of this appliance, please contact your local city office or your household waste disposal service.

Use only attachments, consumables or spares recommended or supplied by Hoover.

Static electricity: Some carpets can cause a small build up of static electricity. Any static discharge is not hazardous to health.

Do not use your appliance out of doors or on any wet surface or for wet pick up.

Do not pick up hard or sharp objects, matches, hot ashes, cigarette ends or other similar items. Do not spray with or pick up flammable liquids, cleaning fluids, aerosols or their vapours.

Do not run over the power cord when using your appliance or remove the plug by pulling on the power cord. Do not continue to use your appliance or charger if it appears faulty.

Hoover service: To ensure the continued safe and efficient operation of this appliance we recommend that any servicing or repairs are only carried out by an authorised Hoover service engineer.

Do not use the appliance to clean animals or people.

Do not replace the batteries with non-rechargeable batteries.

The Environment:

This appliance is marked according to the European directive 2011/65/EC on Waste Electrical and Electronic Equipment (WEEE). By ensuring this product is disposed of correctly, you will help prevent potential negative consequences for the environment and human health, which could otherwise be caused by inappropriate waste handling of this product. The symbol on the product indicates that this product may not be treated as household waste. Instead it shall be handed over to the applicable collection point for the recycling of electrical and electronic equipment. Disposal must be carried out in accordance with local environmental regulations for waste disposal. For more detailed information about treatment, recovery and recycling of this product, please contact your local city office, your household waste disposal service or the shop where you purchased the product.



This product complies with the European Directives 2014/35/EU, 2014/30/EU and 2011/65/EU.

CANDY HOOVER GROUP S.r.l. Via Privata Eden Fumagalli, 20861 Brugherio (MB) Italy

PRODUCT COMPONENTS

- | | |
|-----------------------------|---|
| A. Wall Mount* | R. Single Cyclone |
| B. Wall Mount Screws* | S. Battery Pack |
| C. Main Body | Sa. Battery Pack Release Buttons |
| D. Turbo Button | Sb. Battery Pack Charging Inlet |
| E. Main Body Release Button | Sc. Battery Pack Charging/Discharging Led Light |
| F. Tube | T. Battery Pack Charger |
| G. Nozzle Release Button | Ua. On/Off Switch |
| H. Nozzle | Ub. Continuous Mode Lever |
| I. Agitator Release Flap | V. Exhaust Filter Release Buttons |
| J. Nozzle Front LED | W. Exhaust Filter |
| K. Brush Bar Status | X. 2 In1 Large Dusting And Furniture Tool* |
| La. Intense Floor Roller | Y. 2 In1 Crevice And Dusting Tool* |
| Lb. Deep Care Roller | Z. Mini-Turbo Nozzle* |
| Lc. Rear Soft Strip | AA. Accessory Adaptor* |
| M. Wiper Blade | AB. Radiator Tool* |
| N. Dust Cup | AC. Deep Cleaning Brush* |
| O. Dust Cup Empty Button | AD. Multi-Function Up To Top Tool* |
| P. Mesh Filter | AE. Long Flexible Crevice Tool* |
| Q. Single Cyclone Separator | |

PREPARING YOUR CLEANER

1. On first use, fully charge the appliance battery by connecting the charger jack plug to the battery pack. Charging time is approximately 5Hrs. The battery pack LED light will illuminate Red during charging and will turn WHITE when fully charged. [1]
 2. Assemble the tube to the nozzle until you hear it "click" into place. [2a]
 3. Assemble the main body unit to the tube until you hear it "click" into place. [2b]
- NOTE:** To remove the nozzle press the nozzle release button and pull away from the main body.
- NOTE:** Use only the charger supplied with your cleaner to recharge.
- IMPORTANT:** When charging the cleaner the switch lever must be in the OFF position. You can charge the removable battery pack also when released from the product.
- It is normal for the charger to become warm to touch when charging.

* Certain Models Only

USING YOUR CLEANER

There are three working modes:

- **STANDARD MODE:** When you press ON-OFF switch, the cleaner is ready to clean thoroughly with the main motorised nozzle. [3a]

NOTE: Standard mode is recommended to clean hard floors and above floors.

- **CONTINUOUS MODE:** To enable continuous mode you can pull switch lever back and it will click into place. To disable continuous mode you can push the switch lever forward. [3b]

- **TURBO MODE:** Press the Turbo button to fully power the product for hard cleaning tasks. [3c]

IMPORTANT: After each use of your product, please ensure to push the switch lever forward to the unlocked position. Failure to do so may result in a reduction in battery life or failure.

SELECT SUITABLE ROLLER FOR BEST CLEANING

Intense Floor roller*: It is recommended to use on carpet which can go deep into the carpet to clean the dust.

Deep Care roller*: It is recommended to use on hard floor or delicate parquet. Thank to the soft bristles you can gently clean those type of floors.

IMPORTANT: Always switch off the cleaner before changing and cleaning the agitator.

NOTE: To fit the Roller you would like to use: [18]

1. Detach the agitator release button flap. It is positioned on the lateral part of the nozzle.
2. Hold the agitator release flap and pull down to remove the agitator.
3. Replace with Intense Floor Roller or with the Deep Care Roller.
4. Re-fit in position the agitator release flap.

BATTERY

When the battery is discharging in normal use, the battery pack LED is white. When the Battery capacity is lower than 5%, the WHITE LED light will begin to flash. [4] When this happens you should stop cleaning and immediately recharge your battery, the LED will be RED during the charging. [1] When charging the product, the continuous switch lever must be in the OFF position, it is also possible to charge the battery pack when released from the product.

NOTE: If you are not going to use the cleaner for a long period of time, please remove the battery pack from the cleaner to maintain the battery life.

WIPER BLADE ASSEMBLY

To obtain the best crevice and carpet performance, it is recommended to assemble the front and rear wiper blades to the soleplate of the nozzle.

To do this, open the agitator release flap and remove the soft strip. Then grip one wiper blade, by inserting one end into the rear slot and slide it in until fully home. Repeat these operations for the second wiper blade and slide it in the front slot. Lock the agitator release flap. [5]

SAFETY PROTECTION SYSTEM

To ensure the reliability of the product is not affected if used under arduous conditions, the product features an integrated safety protection system.

NOTE: The Safety protection system will action if the agitator has a blockage or is locked, once actioned the agitator will stop rotating, the white Led lights on the front of the nozzle will go out [6a] and the WHITE Led light on the top of the nozzle will turn red. [6b] If this happens, simply switch off your product and clear the agitator obstruction. To resume cleaning, press the on/off button and the product will restart in normal mode.

ACCESSORIES*

2in1 CREVICE & DUSTING TOOL*, 2in1 LARGE DUSTING & FURNITURE TOOL*, LONG FLEXIBLE CREVICE TOOL*, MULTI FUNCTION UP TO TOP TOOL* AND MINI TURBO NOZZLE*

The above accessories can be fitted directly into the main body unit or the tube. [7]

NOTE: To remove the nozzle or main body unit from the tube, press the respective release button and pull apart.

* Certain Models Only

RADIATOR TOOL* / DEEP CLEANING BRUSH*

The accessory adaptor* must be fitted when using these 2 accessories. [7]

NOTE: The mini-turbo nozzle is ideal for deep cleaning textile surfaces (i.e. sofas) and pet hair removal. Move it steadily backwards and forwards. After using, please remove hair / threads collected on the brush with scissors if necessary.

NOTE: The long flexible crevice tool is ideal for cleaning in hard to reach areas, underneath furniture and in your car.

NOTE: The radiator tool is ideal for cleaning inside and around cabinets, radiators, couches, blinds and more.

NOTE: The deep cleaning brush is useful to clean in tight spaces without scratching surfaces, and inside your car.

NOTE: The multi-function tool is designed to easily clean delicate surfaces without scratching and all areas that are hard to access or reach. The multi-function tool is made up of three key parts:

1. Crevice tool this is ideal for accessing tight spaces.
2. Dusting brush is ideal for cleaning surfaces without damaging or scratching.
3. Furniture Nozzle is ideal for cleaning surfaces like sofa.

ACCESSORY BAG*

Accessories can be stored in the accessory bag.

WALL MOUNT*

For storage and space saving, your appliance can be fixed to your wall using the three screws and screw plugs included.

The product, 2in1 Crevice and Dusting Tool and the 2 in1 Large Dusting and Furniture Tool can be stored on the wall mount. [8]

CLEANER MAINTENANCE**Emptying the Dust Container**

1. Press the main body release button and remove the tube. [9]
2. Press the dust cup empty button to release the bin flap and empty the contents. [10]
3. Close the dust cup flap, you will hear a click when fully locked.

NOTE: It is recommended to empty the dust cup after each use or when dust is up to the max fill line.

Cleaning the Dust Container and Filter

1. Press the main body release button and remove the tube. [9]
2. Press the dust cup empty button to release the bin flap and empty the contents. [10]
3. Close the dust cup flap, you will hear a click when fully locked.
4. Press the two battery pack release buttons and remove the battery pack from the main body. [11]
5. Turn the dust bin clockwise direction, align the arrow marks and remove from the main body. [12]
6. Turn the mesh filter clockwise direction and remove it from the single cyclone separator. [13]
7. Turn the single cyclone separator clockwise direction, align the arrow marks and remove it from the main body. [14]
8. Press the two exhaust filter release buttons and remove the exhaust filter from the main body. [15]
9. Wipe clean the single cyclone with a dry cloth. Wash the exhaust filter, dust cup, mesh filter and single cyclone separator in lukewarm water [16], leave to dry for 24 hours. [17] Ensure all components are fully dry before refitting to the main body.

NOTE: do not use hot water or detergents when cleaning the exhaust filter. In the unlikely event of the exhaust filter becoming damaged, fit a genuine Hoover replacement. Do not use the product without a filter fitted.

IMPORTANT: for optimum performance, always keep your mesh filter clean. We recommend that the filter should be washed at least once a month.

Changing and Cleaning the Agitator

IMPORTANT: Always switch off the cleaner before changing and cleaning the agitator.

1. Detach the agitator release button flap. It is positioned on the lateral part of the nozzle. [18a]
2. Hold the agitator release flap and remove the Intense Floor Roller. [18b]
3. To clean the Intense Floor Roller, remove excess debris using scissors. [18c]
4. To clean the Deep Care Roller, rinse with water [18d] and leave to dry for 24hrs. [18e]
5. Re-fit the Deep Care Roller. [18f] The agitator can only fit in one direction.
6. Close the agitator release flap to secure the Deep Care Roller in position. [18g]

Replacing the Batteries

This cleaner is fitted with a rechargeable lithium ion battery pack which is replaceable.

WARNING: only use approved replacement parts for your cleaner. Using parts not validated by Hoover are dangerous and will invalidate your guarantee.

WARNING: do not try to open the battery pack and repair it by yourself.

* Certain Models Only

1. Press the battery pack release buttons and slide to remove. [11]
2. Replace the old battery pack with the new battery pack.
3. Dispose of the batteries safely. Used batteries should be taken to a recycling station and not disposed of with household waste.

TROUBLE SHOOTING

Should you have any problem with you cleaner, follow this simple check list before calling the Hoover Customer Service Centre:

A. Cleaner does not switch on

- Check if the battery pack is charged.
- Check if the battery pack is assembled in place.

B. Loss of suction or no suction

- Empty the dust cup and wash the exhaust filter & mesh filter and cyclone separator.
- Remove the nozzle and check for any blockages in the duct.

C. Batteries cannot be charged

- This may be a result of very long storage periods (over half year).
- Contact Hoover customer service to arrange battery replacement.
- If the problem persists, contact the Hoover customer service center.

HOOVER SPARES AND CONSUMABLES

Always replace parts with genuine Hoover spares. These are available from your local Hoover dealer or direct from Hoover. When ordering parts always quote your model number.

YOUR GUARANTEE

The guarantee conditions for this appliance are as defined by our representative in the country in which it is sold. Details regarding these conditions can be obtained from the dealer from whom the appliance was purchased. The bill of sale or receipt must be produced when making any claim under the terms of this guarantee.

IMPORTANT: The battery in this cleaner is guaranteed for 6 months from the date of purchase. After 6 months the customer is liable for the cost of a new battery.

Subject to change without notice.